



1.0SMB SERIES
SMBG Plastic-Encapsulate Diodes

1.0SMB SERIES Transient Voltage Suppressor Diodes

Features

- P_{PP} 1000W
- V_{RWM} 5.8V- 450V

- Glass passivated chip

Applications

- Clamping Voltage

Marking

- 1.0SMBXXCA/XXA
XX : From 6.8 To 530

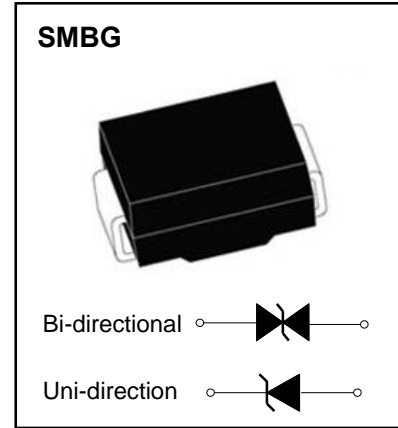

Limiting Values (Absolute Maximum Rating)

Item	Symbol	Unit	Conditions	Max
Peak pulse power dissipation	P _{PPM}	W	with a 10/1000us waveform	1000
Peak pulse current (1)	I _{PPM}	A	with a 10/1000us waveform	See Next Table
Power dissipation	P _D	W	On infinite heat sink at T _L =75°C	5.0
Peak forward surge current(2)	I _{FSM}	A	8.3 ms single half sine-wave unidirectional only	100
Operating junction and storage temperature range	T _J , T _{STG}	°C		-55 to +150

Electrical Characteristics (T_a=25°C Unless otherwise specified)

Item	Symbol	Unit	Conditions	Max
Maximum instantaneous forward Voltage (3)	V _F	V	at 50A for unidirectional only	3.5/6.5
Thermal resistance	R _{θJL}	°C/W	junction to lead	20
	R _{θJA}	°C/W	junction to ambient, L _{Lead} = 10 mm	100

Notes:

- (1) Non-repetitive current pulse, per Fig. 3 and derated above T_A = 25°C per Fig.2.
- (2) Mounted on 0.2 x 0.2" (5.0 x 5.0 mm) copper pads to each terminal
- (3) VF<3.5V for devices of VBR<200V and VF<5.0V for devices of VBR>201V

Electrical Characteristics ($T_A=25^\circ\text{C}$ unless otherwise noted)

Part Number		Reverse Stand-off Voltage	Breakdown Voltage V_{BR} @ I_T		Test Current	Max. Clamping Voltage @ I_{PP}	Max. Peak Pulse Current	Max. Reverse Leakage @ V_{RWM}
UNI-POLAR	BI-POLAR	$V_{RWM}(V)$	Min.(V)	Max.(V)	$I_T(mA)$	$V_{C\ MAX.}(V)$	$I_{PP}(A)$	$I_R(\mu A)$
1.0SMB6.8A	1.0SMB6.8CA	5.8	6.45	7.14	10	10.5	97.50	1000
1.0SMB7.5A	1.0SMB7.5CA	6.4	7.13	7.88	10	11.3	90.75	500
1.0SMB8.2A	1.0SMB8.2CA	7.0	7.79	8.61	10	12.1	84.75	200
1.0SMB9.1A	1.0SMB9.1CA	7.8	8.65	9.55	1	13.4	76.50	50
1.0SMB10A	1.0SMB10CA	8.6	9.50	10.50	1	14.5	70.75	10
1.0SMB11A	1.0SMB11CA	9.4	10.50	11.60	1	15.6	65.75	5
1.0SMB12A	1.0SMB12CA	10.2	11.40	12.60	1	16.7	61.50	5
1.0SMB13A	1.0SMB13CA	11.1	12.40	13.70	1	18.2	56.25	1
1.0SMB15A	1.0SMB15CA	12.8	14.30	15.80	1	21.2	48.25	1
1.0SMB16A	1.0SMB16CA	13.6	15.20	16.80	1	22.5	45.50	1
1.0SMB18A	1.0SMB18CA	15.3	17.10	18.90	1	25.5	40.25	1
1.0SMB20A	1.0SMB20CA	17.1	19.00	21.00	1	27.7	37.00	1
1.0SMB22A	1.0SMB22CA	18.8	20.90	23.10	1	30.6	33.50	1
1.0SMB24A	1.0SMB24CA	20.5	22.80	25.20	1	33.2	30.75	1
1.0SMB27A	1.0SMB27CA	23.1	25.70	28.40	1	37.5	27.25	1
1.0SMB30A	1.0SMB30CA	25.6	28.50	31.50	1	41.4	24.75	1
1.0SMB33A	1.0SMB33CA	28.2	31.40	34.70	1	45.7	22.50	1
1.0SMB36A	1.0SMB36CA	30.8	34.20	37.80	1	49.9	20.50	1
1.0SMB39A	1.0SMB39CA	33.3	37.1	41.00	1	53.9	19.00	1
1.0SMB43A	1.0SMB43CA	36.8	40.90	45.20	1	59.3	17.25	1
1.0SMB47A	1.0SMB47CA	40.2	44.70	49.40	1	64.8	15.75	1
1.0SMB51A	1.0SMB51CA	43.6	48.50	53.60	1	70.1	14.50	1
1.0SMB56A	1.0SMB56CA	47.8	53.20	58.80	1	77.0	13.25	1
1.0SMB62A	1.0SMB62CA	53.0	58.90	65.10	1	85.0	12.00	1
1.0SMB68A	1.0SMB68CA	58.1	64.60	71.40	1	92.0	11.25	1
1.0SMB75A	1.0SMB75CA	64.1	71.30	78.80	1	103.0	10.00	1
1.0SMB82A	1.0SMB82CA	70.1	77.90	86.10	1	113.0	9.00	1
1.0SMB91A	1.0SMB91CA	77.8	86.50	95.50	1	125.0	8.25	1
1.0SMB100A	1.0SMB100CA	85.5	95.0	105.0	1	137.0	7.50	1
1.0SMB110A	1.0SMB110CA	94.0	105.0	116.0	1	152.0	6.75	1
1.0SMB120A	1.0SMB120CA	102.0	114.0	126.0	1	165.0	6.25	1
1.0SMB130A	1.0SMB130CA	111.0	124.0	137.0	1	179.0	5.75	1
1.0SMB150A	1.0SMB150CA	128.0	143.0	158.0	1	207.0	5.00	1
1.0SMB160A	1.0SMB160CA	136.0	152.0	168.0	1	219.0	4.75	1
1.0SMB170A	1.0SMB170CA	145.0	162.0	179.0	1	234.0	4.50	1
1.0SMB180A	1.0SMB180CA	154.0	171.0	189.0	1	246.0	4.25	1
1.0SMB200A	1.0SMB200CA	171.0	190.0	210.0	1	274.0	3.75	1
1.0SMB220A	1.0SMB220CA	185.0	209.0	231.0	1	328.0	3.25	1
1.0SMB250A	1.0SMB250CA	214.0	237.0	263.0	1	344.0	3.00	1
1.0SMB300A	1.0SMB300CA	256.0	285.0	315.0	1	414.0	2.50	1
1.0SMB350A	1.0SMB350CA	300.0	332.0	368.0	1	482.0	2.25	1
1.0SMB400A	1.0SMB400CA	342.0	380.0	420.0	1	548.0	2.00	1
1.0SMB440A	1.0SMB440CA	376.0	418.0	462.0	1	602.0	1.75	1
1.0SMB480A	1.0SMB480CA	408.0	456.0	504.0	1	658.0	1.50	1
1.0SMB510A	1.0SMB510CA	434.0	485.0	535.0	1	698.0	1.50	1
1.0SMB530A	1.0SMB530CA	450.0	503.0	556.0	1	725.0	1.50	1

Typical Characteristics

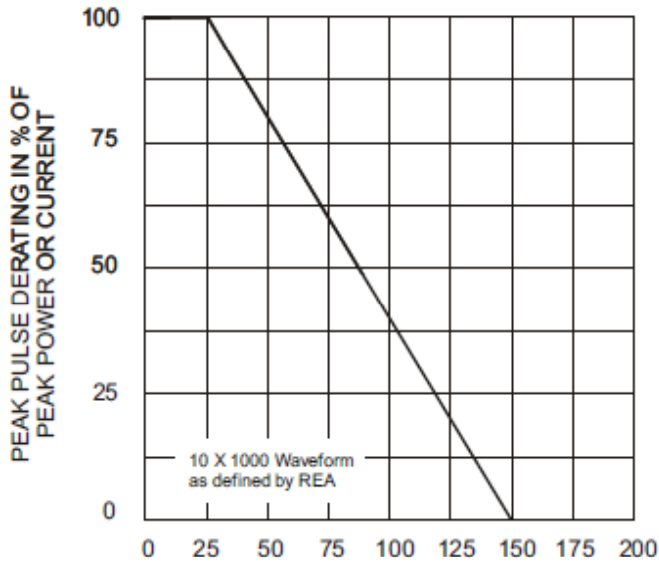

Fig. 1 - Pulse Derating Curve

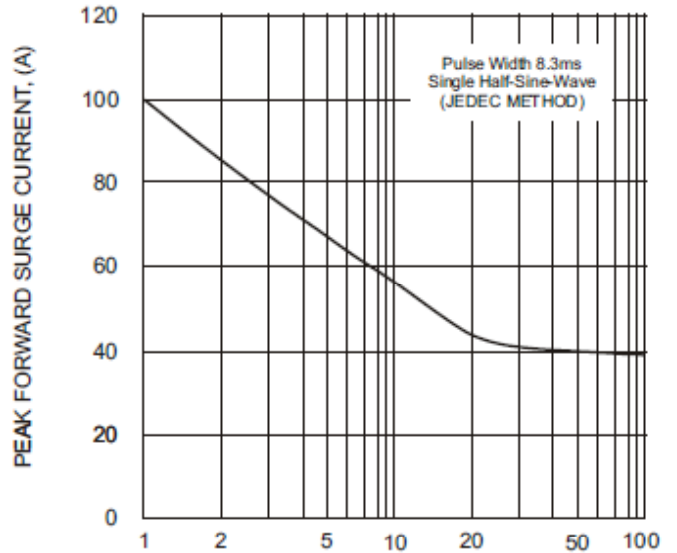

Fig. 2 - Maximum Non-Repetitive Surge Current

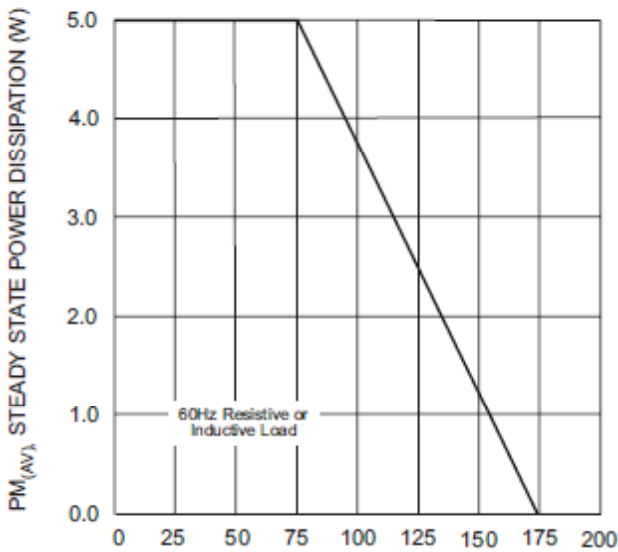

Fig. 3 - Steady State Power Derating Curve

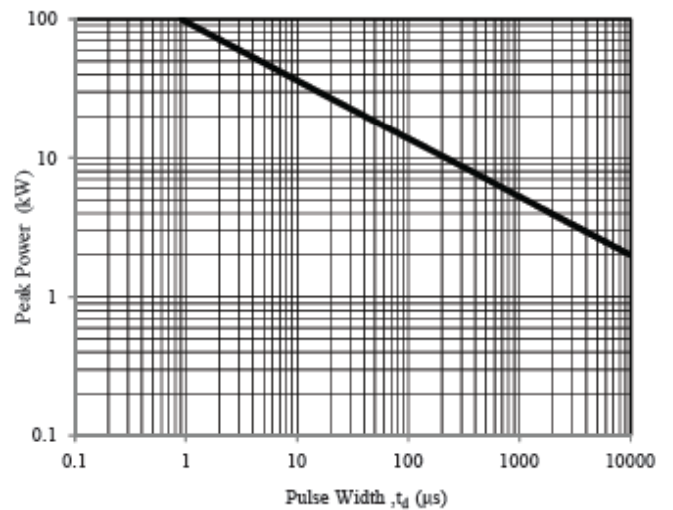

Fig. 4 - Peak Pulse Power Rating Curve

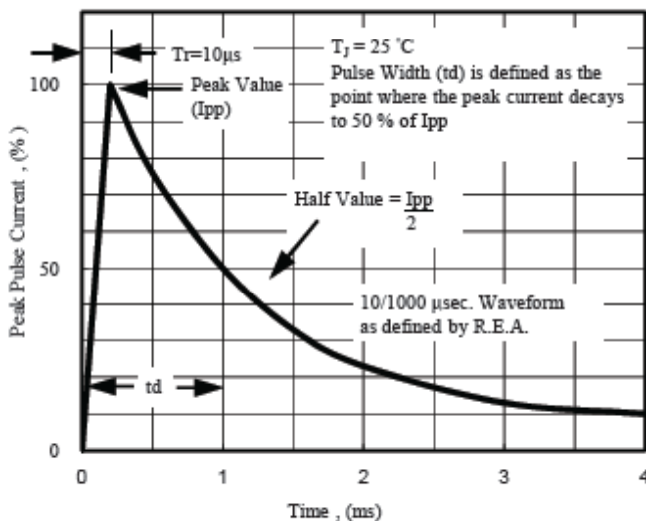

Fig. 5 - Pulse Waveform

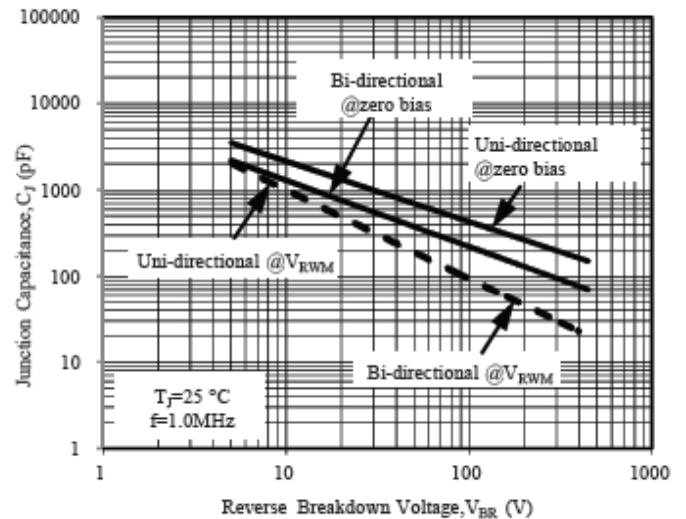
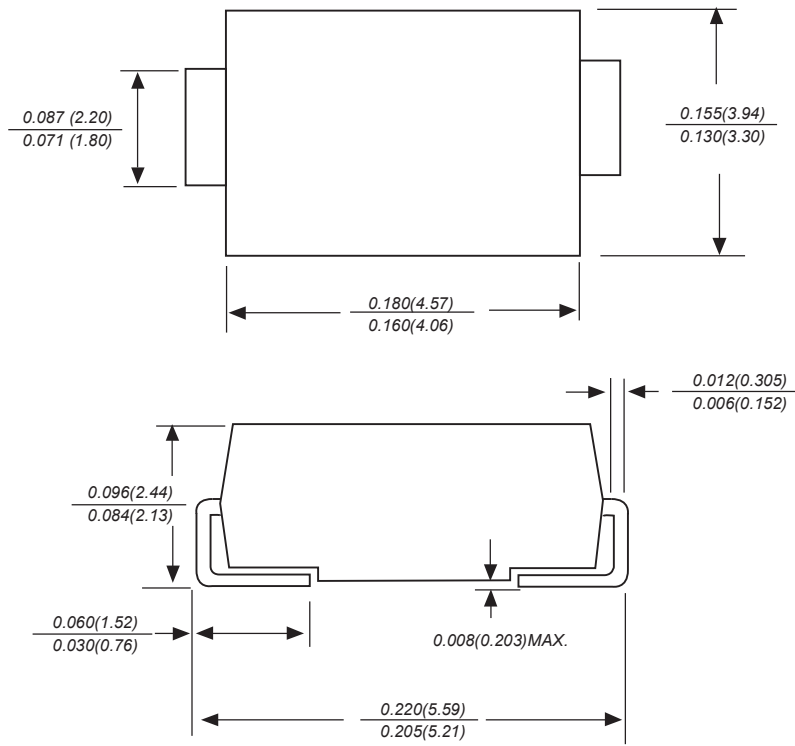

Fig. 6 - Typical Junction Capacitance

SMBG Package Outline Dimensions



Dimensions in inches and (millimeters)

SMBG Suggested Pad Layout

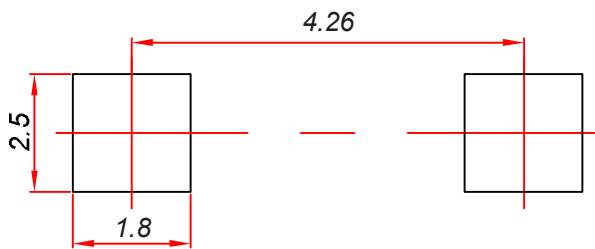

Note:

1. Controlling dimension: in millimeters.
2. General tolerance: $\pm 0.05 \text{ mm}$.
3. The pad layout is for reference purposes only.

NOTICE

JSCJ reserves the right to make modifications, enhancements, improvements, corrections or other changes without further notice to any product herein. JSCJ does not assume any liability arising out of the application or use of any product described herein.

Reel Taping Specifications For Surface Mount Devices- SMBG

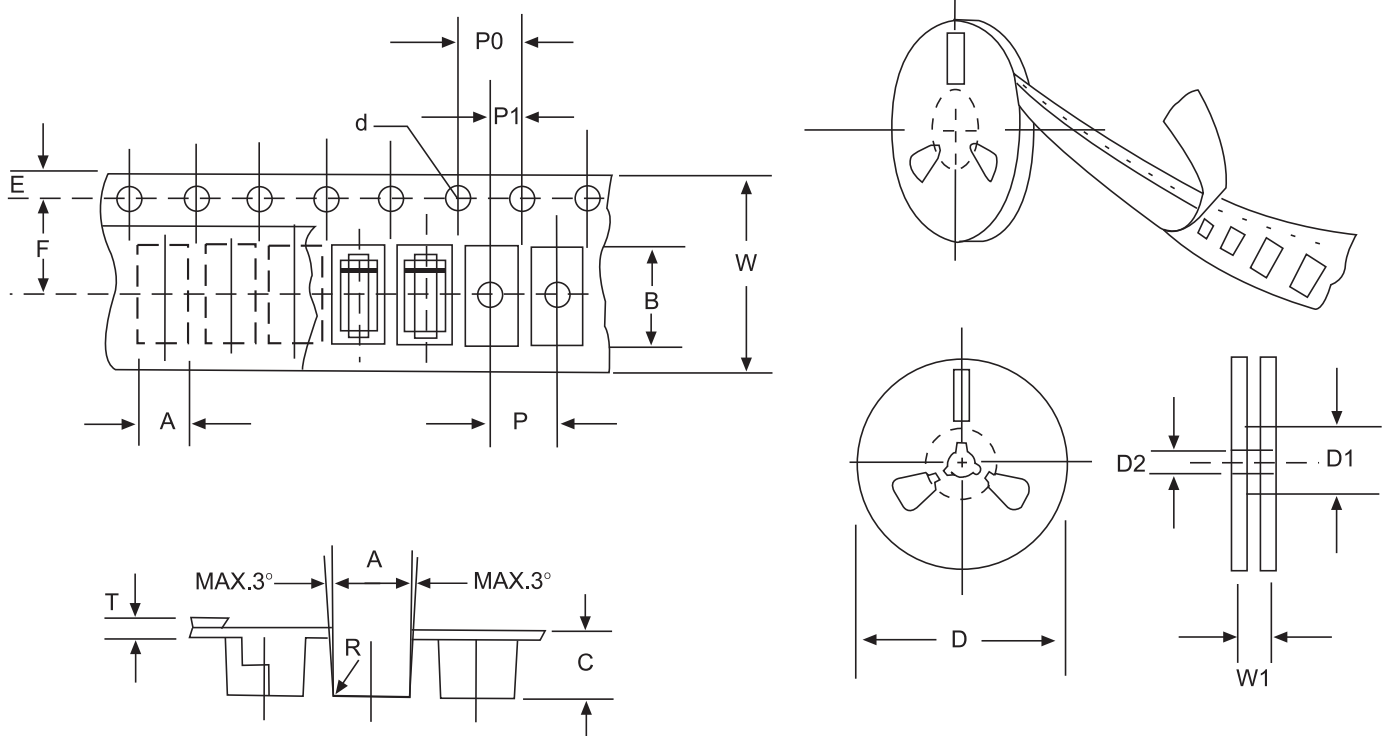

FIG: CONFIGURATION OF SURFACE MOUNTED DEVICES TAPING

ITEM	SYMBOL	SMBG mm(inch)
Carrier width	A	4.09±0.1(0.161±0.004)
Carrier length	B	5.82±0.1(0.229±0.004)
Carrier depth	C	2.50±0.1(0.100±0.004)
Sprocket hole	d	1.55±0.05(0.061±0.002)
Reel outside diameter	D	330±2.0(13±0.079)
Reel inner diameter	D1	75±1.0 (2.95 ±0.039)
Feed hole diameter	D2	13±0.5(0.512±0.020)
Sprocket hole position	E	1.75±0.1(0.069±0.004)
Punch hole position	F	5.65±0.05(0.222±0.002)
Punch hole pitch	P	8.0±0.1(0.315±0.004)
Sprocket hole pitch	P0	4.0±0.1(0.157±0.004)
Embossment center	P1	2.0±0.1(0.079±0.004)
Totall tape thickness	T	0.32±0,1(0,013±0.004)
Tape width	W	12.0±0.2(0.472±0.008)
Reel width	W1	16.8±2.0(0.661±0.079)

NOTE: Devices are packed in accordance with EIA standard RS-481-A and specification given above.